



Cover 2:
Festival Royal Blue

Cover 3:
Salute Pattern Silver

Cover 1:
Cord Silver

Chrome Feet

Salute Collection

Colours represented are to be used as a guide only.
Please refer to manufacturers swatch for a more accurate colour match.

Please note that colour shadings can vary slightly from each roll of fabric.
We cannot guarantee a precise match to these samples or between cut lengths and upholstered goods.

02/11/2020

SALUTE COVER GUIDE - STANDARD BACK

Please use this guide when ordering the following pieces to clarify cover options.

STANDARD BACK

L2, RFC (LH2, RFC) Group

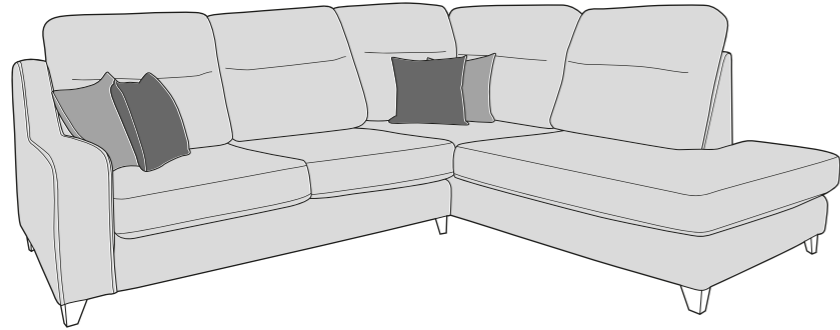

LFC, R2 (LFC, RH2) Group

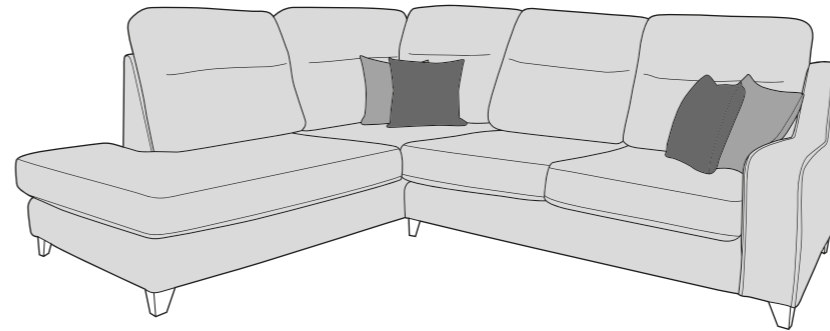

L2, R2C (LH2, R2C) Group

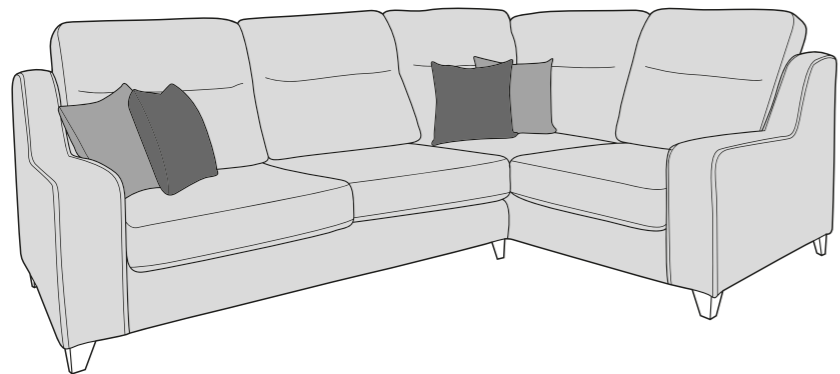

L2C, R2 (L2C, RH2) Group

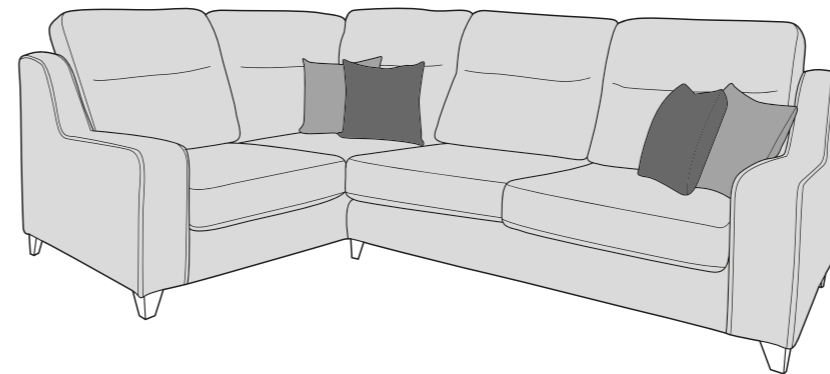

3 Seater sofa (3ST)

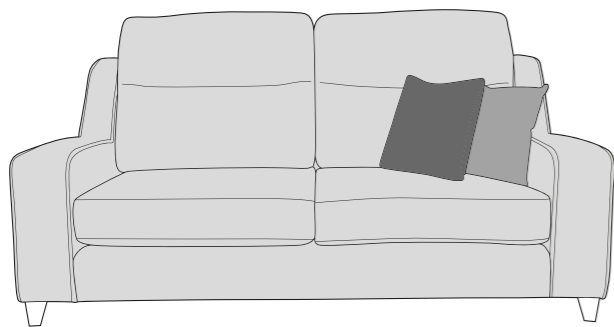

2 Seater sofa (2ST)

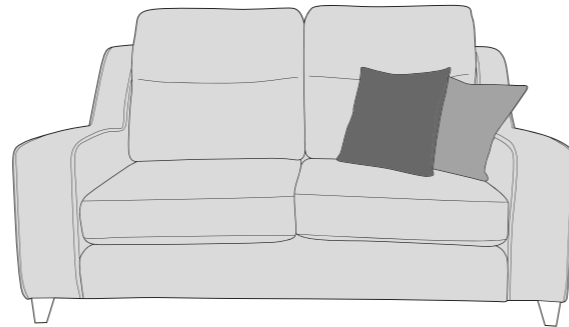

Arm Chair (1ST)

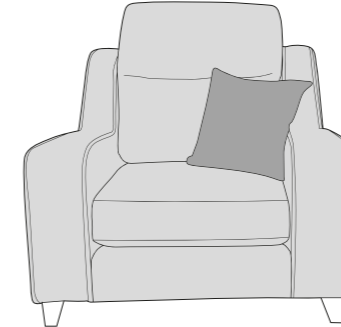

ACCENT PIECES

Salute Swivel Chair (SWC)

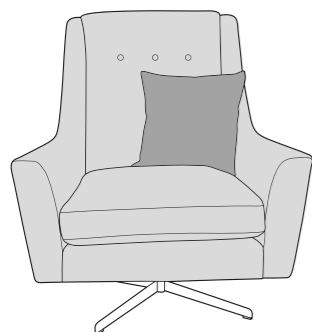

Salute (Sinatra) Accent Chair (ACH)

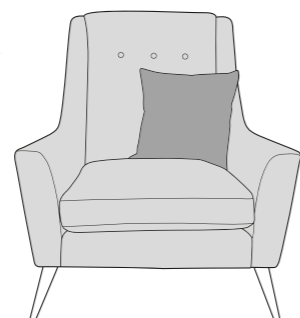

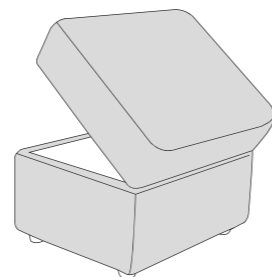

Storage Footstool (FSS)

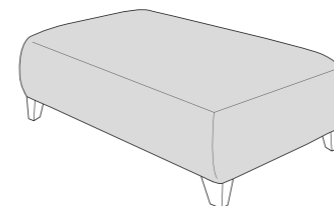

Salute Footstool (FST)



-  **COVER 1**
(BODY)
-  **COVER 2**
(SCATTER)
-  **COVER 3**
(SCATTER)

Scatter Cushions

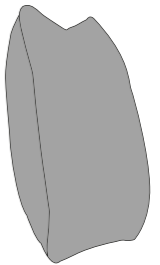

Front = Cover 2
Back = Cover 2

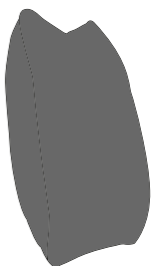

Front = Cover 3
Back = Cover 3



APPROVED MEMBER



SALUTE DIMENSIONS (CM)

AVAILABLE PIECES	HEIGHT 1	OUTBACK HEIGHT	WIDTH 2	DEPTH 3	ARM HEIGHT	SEAT HEIGHT 4	SEAT DEPTH 5	SEAT WIDTH 6	ACCESS DIAGONAL 7	WEIGHT (KG)	SCATTER CUSHION NO.
L2, RFC GROUP or LFC, R2 GROUP	100	82	278	226	58	44	N/A	N/A	N/A	102	4
L2, R2C GROUP or L2C, R2 GROUP	100	82	278	194	58	44	N/A	N/A	N/A	106	4
L2/R2 UNIT	100	82	177	101	58	46	62	157	196	48.5	2
LFC/RFC UNIT	100	82	226	101	N/A	46	62	189	248	53.5	2
L2C/R2C UNIT	100	82	194	101	58	46	62	137	216	57.5	2
3 SEATER SOFA	100	82	195	101	58	46	62	153	211	59	2
2 SEATER SOFA	100	82	176	101	58	46	62	135	194	53	2
ARM CHAIR	100	82	102	101	58	46	62	61	136	33.5	1
ACCENT PIECES											
SALUTE SWIVEL CHAIR	100	N/A	90	98	58	42	60	55	121	33.5	1
SINATRA ACCENT CHAIR	100	N/A	90	98	58	42	60	55	121	25.5	1
STORAGE FOOTSTOOL	43	N/A	63	50	N/A	N/A	N/A	N/A	75	13	N/A
SALUTE FOOTSTOOL	40	N/A	103	63	N/A	N/A	N/A	N/A	115	15	N/A



- * Hardwood & composite board frame.
- * Dowelled, screwed, glued & stapled joinery.
- * Chrome & Wood foot options.

- * Reversible high density foam seats for support & comfort.
- * Fibre filled backs for added comfort.
- * Fibre filled scatters included.

- * Serpentine seat springs & silent wire.
- * Elasticated back webbing.

DIMENSION GUIDE

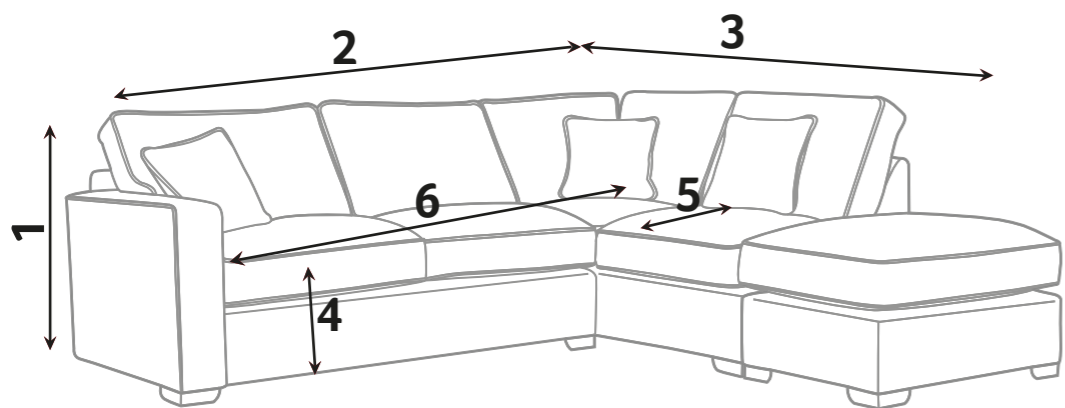

Check the diagonal access dimension to ensure furniture will fit in your home.

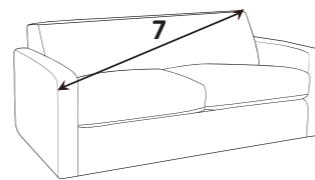

- 1 - HEIGHT
- 2 - WIDTH
- 3 - DEPTH
- 4 - SEAT HEIGHT
- 5 - SEAT DEPTH (STD & PILLOW)
- 6 - SEAT WIDTH
- 7 - DIAGONAL ACCESS

Illustrations used for reference only.

HIGH DENSITY FOAM SEATS

Our high density foam seat interiors offer a comfortable and supportive sit whilst maintaining their shape.

CARE GUIDE

To improve the longevity of your hand-made furniture, we recommend rotating cushions (where applicable).

For further information on maintaining your furniture, please refer to the Care Guide located under the seat platform.

FOOT OPTIONS:



Wood is a natural product and will vary in shade/colour from item to item. Feet may require fitting.

Please note : All dimensions are approximate. Allow tolerance of +/- 2.5cm.

Weight limits per seat: tested according with BS EN 12520:2010 & BS EN 1022:2005 for general domestic use which are based on persons weighing up to a maximum of 110kg.

